

General Service Bulletin (GSB):	Diesel Exhaust Fluid Service Tips
GSB Overview:	In many cases, DEF system concerns are related to petroleum contamination or misdiagnosis. This Service Bulletin is intended to aid in the diagnosis of the DEF system and help aid in determining if the system has been contaminated.
<b>NOTE:</b> This information is not intended to replace or supersede any warranty, parts and service policy, Work Shop Manual (WSM) procedures or technical training or wiring diagram information.	

# Diesel Exhaust Fluid (DEF) General Service Bulletin



## A Guide to Properly Diagnose and Service Ford Reductant systems

# Table of Contents

Topic	Page
<b>DEF System Overview</b>	
General Information.....	3
<b>Reductant System Components</b>	
Reductant Tank.....	7
Heater/Sender Assembly.....	8
Reductant Pump.....	9
Heated Supply Line.....	10
Reductant Injector.....	11
<b>DEF System Diagnostics.....</b>	<b>12</b>
<b>DEF System Service Tips.....</b>	<b>13</b>
<b>IDS Service Functions.....</b>	<b>17</b>

**NOTE:** This GSB is not intended to replace diagnostics listed in the PC/ED and/or Workshop Manual (WSM). It is intended to be an educational aid for understanding DEF system operation, failure modes and proper repair techniques.

# DEF System Overview

## General Information

- Diesel Exhaust Fluid (DEF) also known as Reductant is a fluid comprised of highly purified and deionized water and urea.
- DEF is highly corrosive. Avoid exposure to electrical components.
- It is normal for DEF to freeze at temperatures below 12°F/-11°C.
- Only API certified DEF should be used in Ford reductant systems.
- Ford DEF bottles include a filler spout designed to aid in the filling of Ford specific systems.

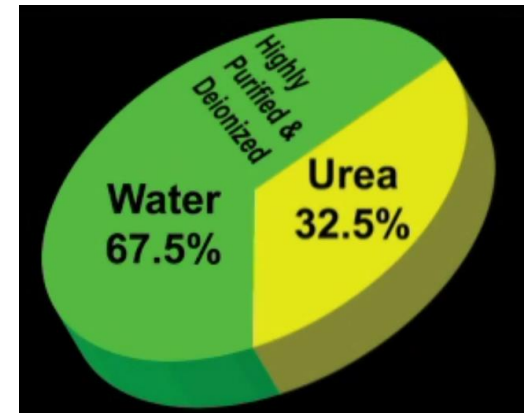

**NOTICE:** Petroleum products (diesel fuel, gasoline, kerosene, fuel additives) will swell the rubber O-rings and seals in all parts of the DEF system and prevent the system from functioning properly. Petroleum contamination cannot be flushed/cleaned and requires the entire system be replaced including the tank, pump, sender, lines and injector. Petroleum contamination is non-warrantable.

# DEF System Overview

General Information

## Typical Diesel Exhaust Fluid (DEF) Usage Chart

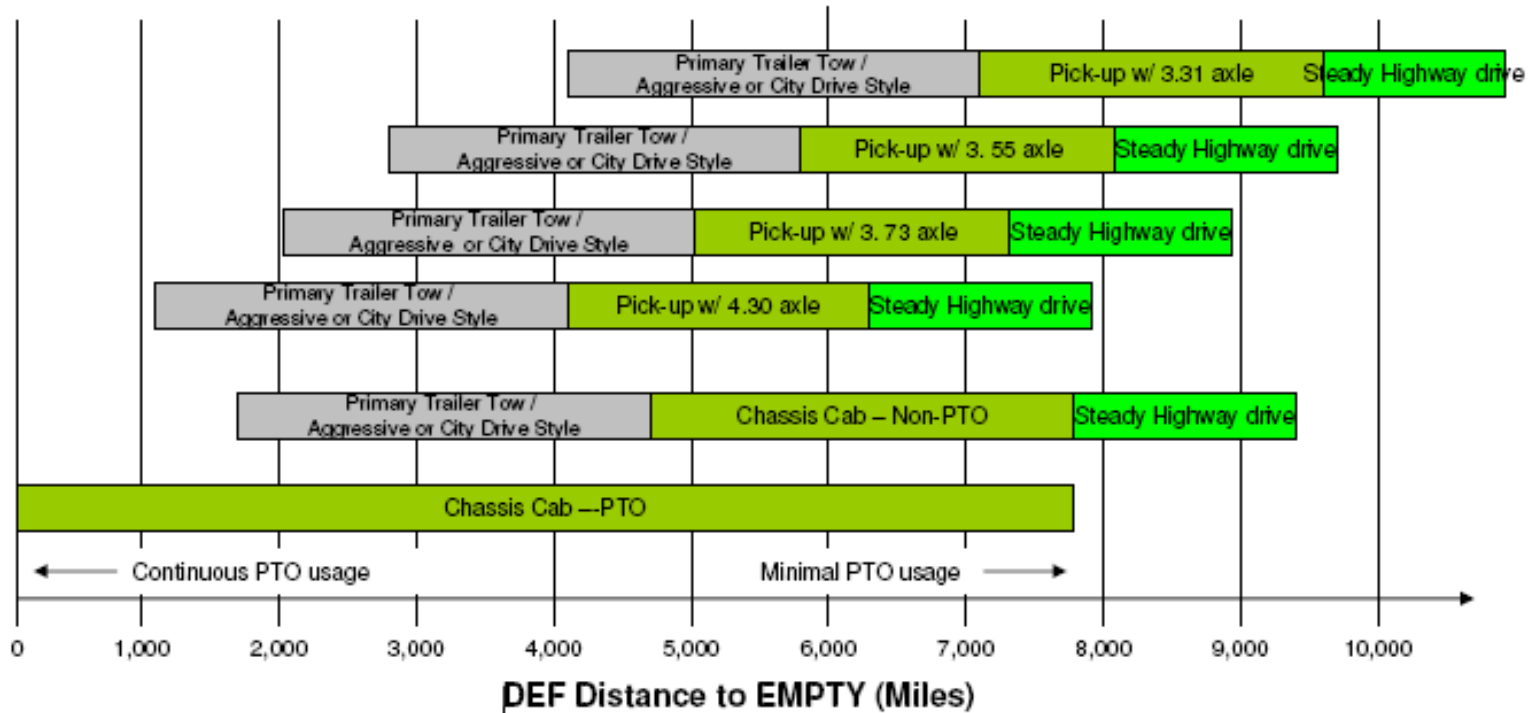

**NOTE:** This chart represents the average distance between DEF refills based on how the vehicle is operated. Customer driving habits, ambient temperature, fuel quality and other factors that influence fuel economy will also impact DEF usage.

## DEF System Overview

### General Information

### *Reductant Tank Filling*

- ❑ All Super Duty vehicles equipped with a 6.7L diesel engine are filled with DEF at KTP and leave the plant with a full tank.
- ❑ Dealerships do NOT need to add any DEF to the tank when received from KTP.
- ❑ The reductant tank is designed with an air space for ice expansion when DEF freezes. Overfilling can result in damage to the tank or components.
- ❑ Specific OASIS SSM available to dealers advising the tank is full as delivered and not to top off as overfill can occur.
- ❑ Owner Manual advises customers that a warning system will automatically tell them when refilling the urea tank is required.
- ❑ Owner Manual includes detailed information including how to avoid overfilling the tank and how to query system for tank level.
- ❑ The reductant tank is designed with an automatic shutoff feature to ensure the tank is filled to the correct level when using Motorcraft DEF bottles.

**NOTE:** When the reductant tank is full, the fluid level in the bottle will stop dropping. Do Not force excess fluid into the tank.



## DEF System Overview

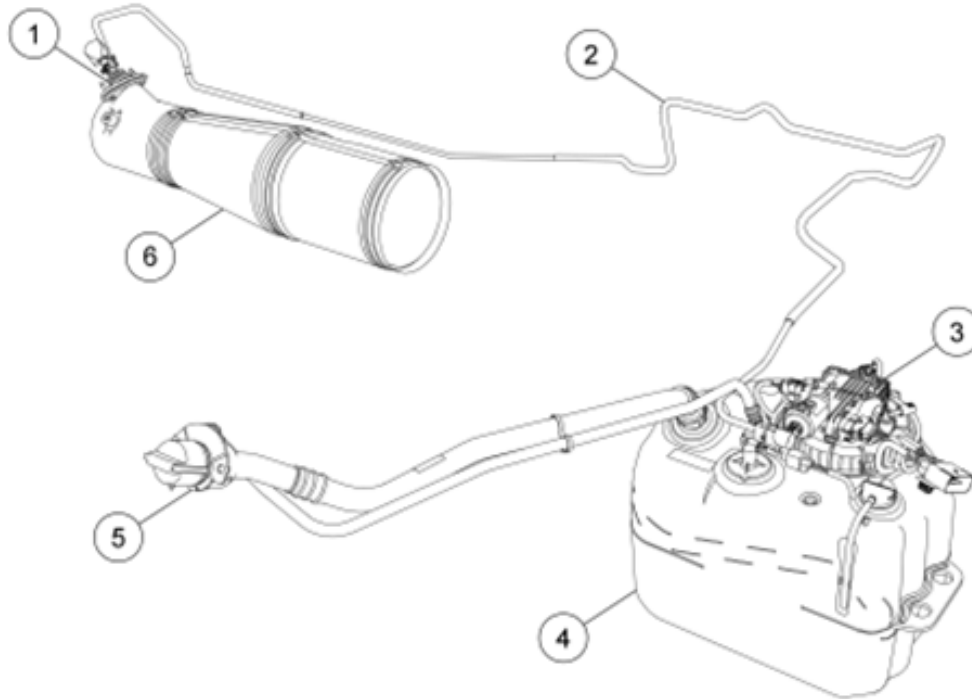

Item	Part number	Description
1	—	Reductant Injector
2	—	Reductant Pressure Line
3	—	Reductant Pump Assembly
4	—	Reductant Tank
5	—	Reductant Tank Filler Hose
6	—	SCR Catalyst

## Reductant System Components

### Pump and Pot Assembly

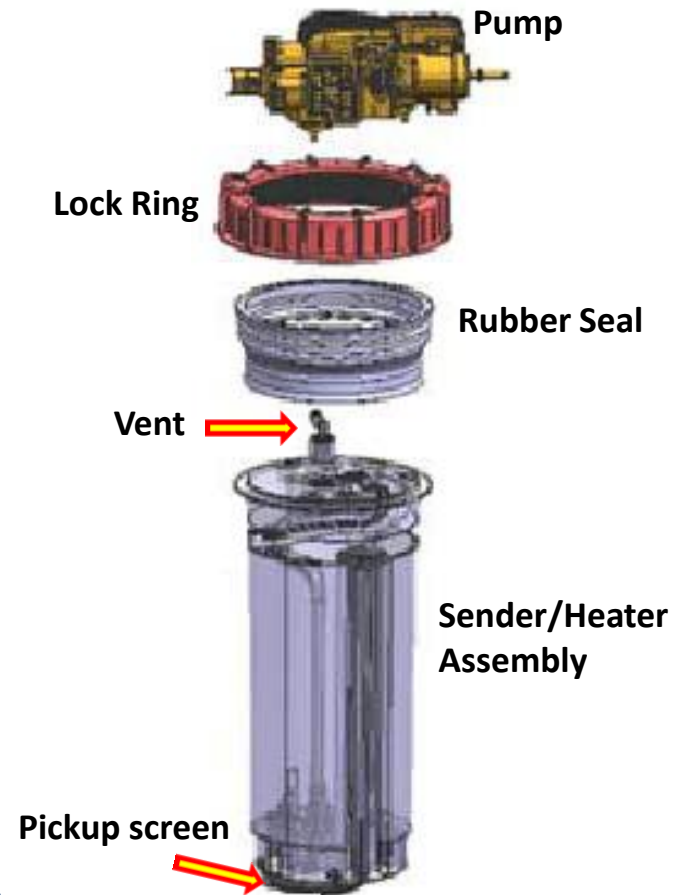

## DEF System Overview

**Reductant System Components:**  
Reductant Tank

**Chassis Cab** (6.2 gal/23.5 ltrs)



DEF filler neck connection

Tank vent to atmosphere

Sender/Heater location

Tank vent to atmosphere

**Pickup Truck** (5.1 gal/19.3 ltrs)

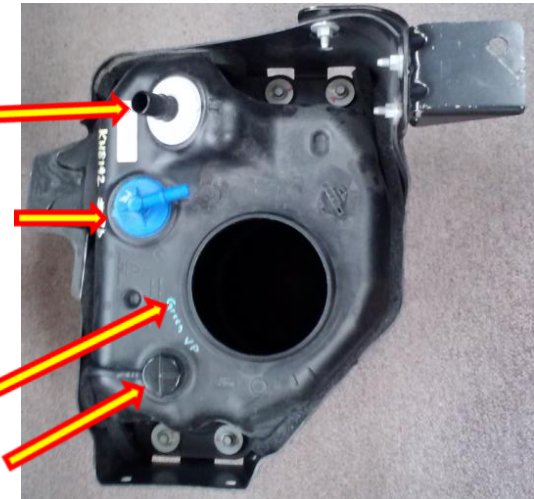

DEF filler neck connection

Fill level valve

- The DEF filler neck connection incorporates a flapper valve to prevent spit-back when filling the tank.
- The fill level valve is designed to prevent overfilling the reductant tank when using Ford approved DEF bottles.
- The tank vent is designed to allow the tank to breath during thermal cycling or during high consumption rates. The vent will not allow liquid to pass into or out of the tank.
- **Chassis Cab and Pickup truck reductant tanks have different capacities are not interchangeable.**

**NOTE:** Petroleum contamination cannot be flushed or cleaned from the reductant tank. If petroleum contaminants are found in the DEF fluid, the entire system including the tank, pump, sender, supply line and injector must be replaced to prevent repeat repairs. Petroleum contamination is non-warrantable.

## DEF System Overview

### Reductant System Components: Heater/Sender Assembly

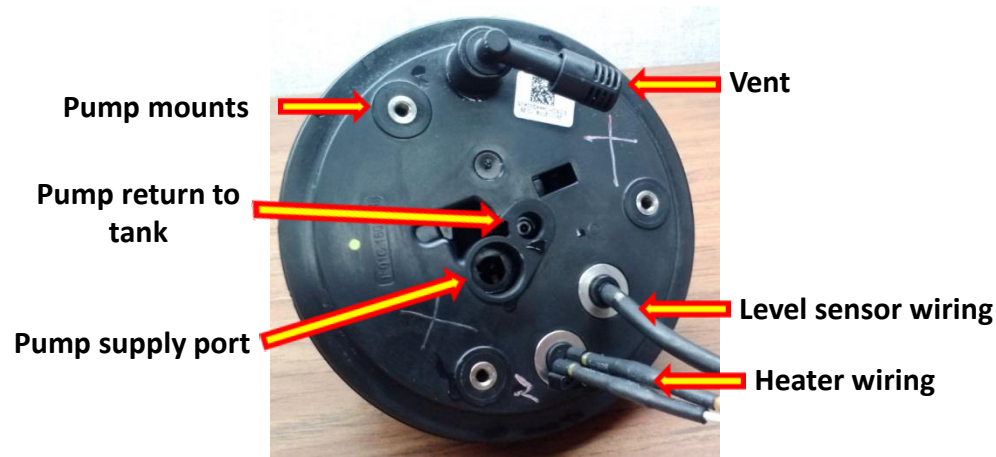
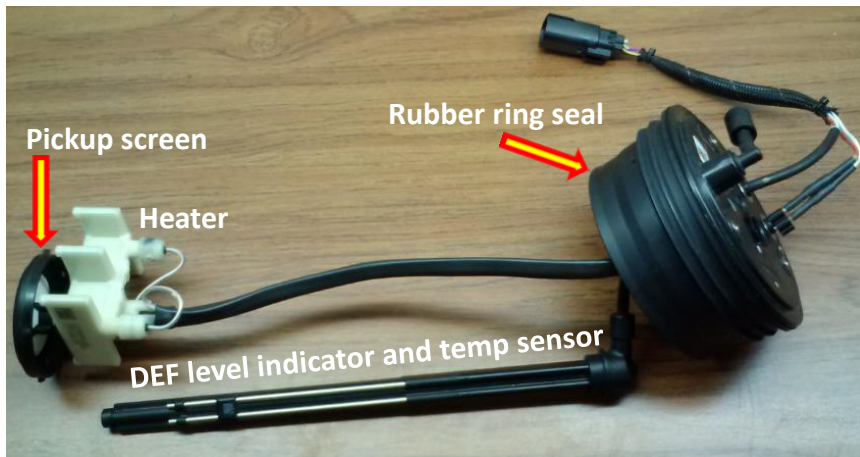

**NOTICE:** Reductant system components removed from pot for clarity. The heater/sender assembly is serviced as an assembly only and cannot be disassembled or removed from the pot for diagnosis/repair.

- The heater/sender assembly consists of the reductant tank heater, level sensor, pickup screen, rubber seal and wiring. **These parts cannot be serviced separately.**
- Below  $-30^{\circ}\text{F}$  ( $-34^{\circ}\text{C}$ ) the DEF system will not be activated by the PCM.
- The level sensor consists of 4 electrodes that measure the fluid level through conductivity . The level sensor only has the capability of reading 0%, 33%, 66%, 100%. Included in the level indicator is a temperature sensor.
- **DTC P203F is an information DTC ONLY and will not set the MIL.** This DTC is only set as an indicator that the operator ran the DEF level low and does not indicate a fault with the level sensor.
- Once the tank has been refilled, upon restart the PCM will recognize the change in DEF level and remove the vehicle from the warning chain. This may require that up to 2.5 gallons be added to the tank for the DEF level to contact the next highest pin for the system to recognize a fill event. If the level increase is not recognized and the tank level reads 100%, the **IDS SCR System Refill Activation** routine should be performed.



## DEF System Overview

### Reductant System Components: Reductant (DEF) Pump Assembly

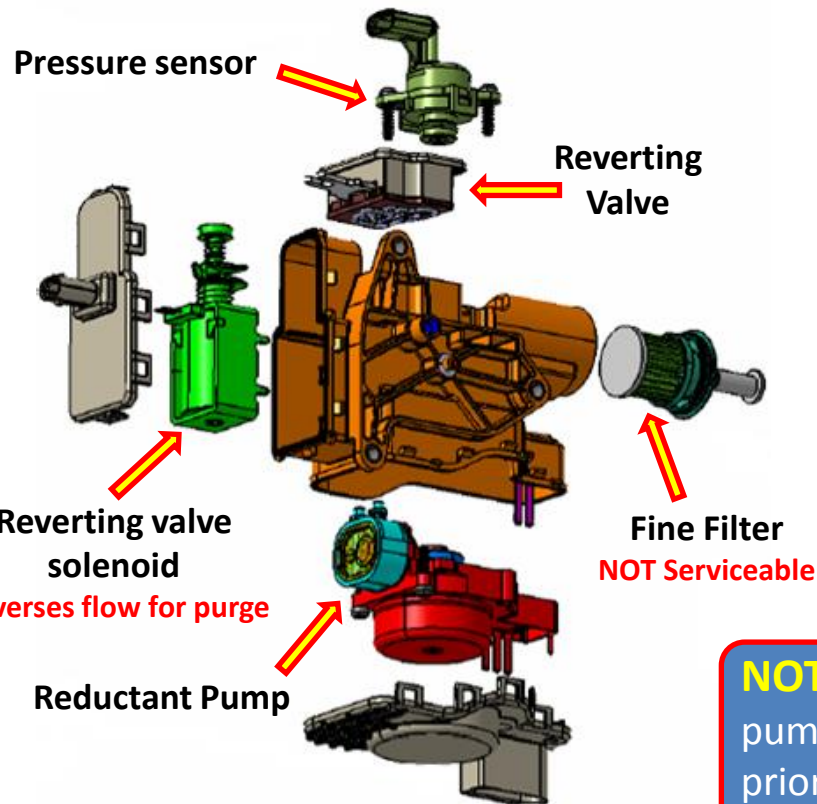

The reductant pump assembly houses the pump, reverting valve and solenoid, the pressure sensor, fine filter and DEF pump screen. **The reductant pump assembly is only serviceable as a complete assembly.**

- The pump is Pulse-Width modulated by the PCM. **Applying 12v to the pump will damage it.**
- When replacing the reductant pump, the priming procedure will need to be performed to prime the system.
- If a vehicle has been sitting for a prolonged period of time, DTC **P20E8** may set due to a dry DEF pump. Please perform the IDS "system leak check" procedure up to 3 times to attempt to build pressure before replacing parts.

DTC **P20E8** relates to the reductant pump.  
DTC **P208E** relates to the reductant injector.

**NOTICE:** Be sure to follow the WSM procedure for reductant pump replacement to ensure the tank is properly cleaned prior to pump removal. To prevent repeat repairs, it is imperative that the DEF fluid is not contaminated and that no dirt/debris enters the pump ports during replacement.

**NOTE:** The most common cause of reductant pump failure is from petroleum contamination. Be sure to test the DEF in the tank for petroleum contamination before replacing any DEF system components.

## DEF System Overview

**Reductant System Components:**  
Heated Reductant (DEF) Supply Line

### **The Heated Reductant Supply Line:**

- Connects the outlet of the reductant pump to the reductant injector.
- Is heated by a wire wound around and encased in the line.
- Is heated to keep DEF in a liquid state in cold ambient temperatures (below 12°F/-11°C).

**Damaged supply lines cannot be repaired, they must be replaced.**



**A key indicator of a damaged supply line is DTC P20BD and/or P20BE**

Shown above are examples of supply lines damaged during vehicle transportation. It is best to inspect this line for damage when the transport company is delivering the vehicle. Concerns related to transportation damage typically show faults at low mileage (under 500 miles), but there have also been failures in higher mileage vehicles. A quick visual inspection on the outside of the frame rail along the passenger side of the vehicle may not find the damaged line. Physically checking the line for a crushed section is the best way to identify a damaged supply line.

## DEF System Overview

### Reductant System Components: Reductant (DEF) Injector

#### The Reductant Injector (Dosing Module):

- The reductant injector is a Pulse Width Modulated (PWM) solenoid controlled directly by the PCM. The injector receives reductant from the reductant pressure line and sprays it into the exhaust stream, where it is mixed into the exhaust gases before entering the catalyst.
- When the vehicle is shut down, the PCM opens the reductant injector and actuates the reductant pump purge valve, causing the reductant pump to reverse the pump flow and evacuate any DEF from the injector and line back to the reductant tank.

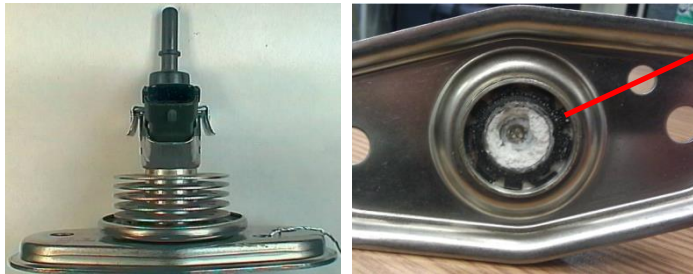
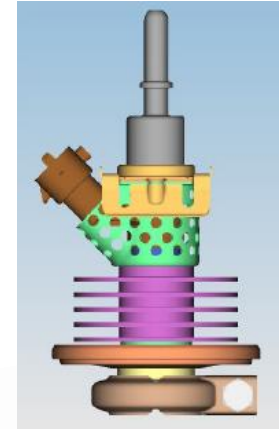

DEF crystals will form on the outlet of the injector. These are normal and will dissolve during normal operation.

**DTC P20E8** relates to the reductant pump.  
**DTC P208E** relates to the reductant injector.

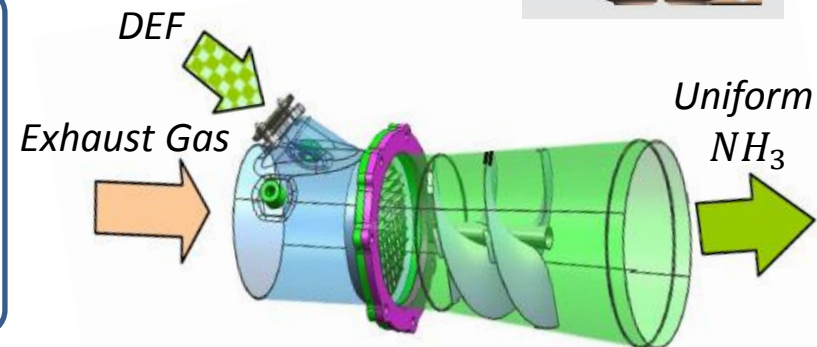

The reductant injector injects DEF into the exhaust system to convert the engine NO<sub>x</sub> gases into ammonia, water and CO<sub>2</sub>. When the system cannot properly convert the NO<sub>x</sub> gases, the PCM will set **DTC P207F** (Reductant Quality performance). This code is typically set due to excess NO<sub>x</sub> entering the exhaust system from a faulty EGR cooler or other upstream emissions fault and not from a fault in the reductant system. If a **P207F** is set by a reductant system component, there will be a DTC relating directly to that part along with the **P207F**.

## DEF System Diagnostics

DEF system contamination is typically in the form of petroleum (diesel fuel, fuel additives, gasoline, kerosene, grease/lube). When petroleum is introduced into the reductant tank, the ring seal of the heater/sender may swell. DEF fluid that is contaminated with petroleum may have a different odor and turn from clear to milky/cloudy. While these can be good initial indicators, smaller amounts of petroleum contamination can be harder to detect. Therefore, Rotunda DEF test strips should be used to determine if the DEF has been contaminated with petroleum.

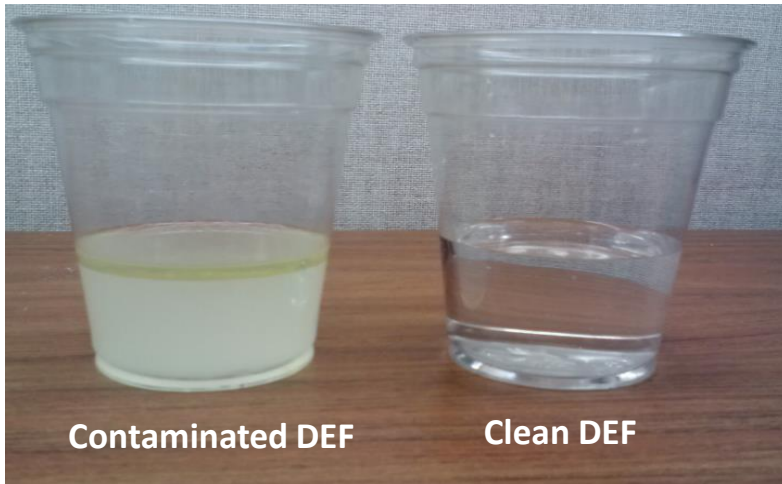

**NOTE:** Be sure to test the DEF in the tank for petroleum contamination before replacing any reductant system components.

## DEF Contamination



**NOTICE:** Repairs required due to the use of improper fluids are not covered by the New Vehicle Limited Warranty, Extended Service Plan (ESP), or Service Part Warranty (SPW). Refer to the Warranty and Policy Manual for details.



Good Seal

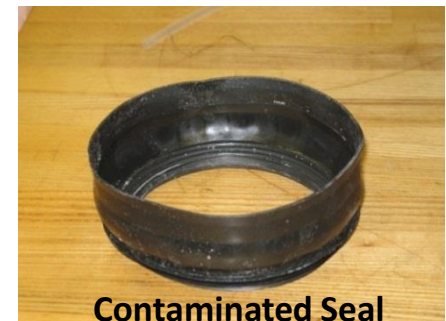

Contaminated Seal

## DEF System Diagnostics

### DEF Contamination

- The most accurate and recommended way to test for petroleum contamination of DEF is the use of Rotunda DEF test strips; **part number 328-00012 or 328-44-863.**
- The DEF fluid obtained for testing should come directly from the tank and not from the injector during a dosing test. Refer to the WSM for reductant tank draining.
- DEF test strips will absorb petroleum and change to a darker color when the petroleum is absorbed into the strip. Clean DEF will not be absorbed by the strip and will bead off.

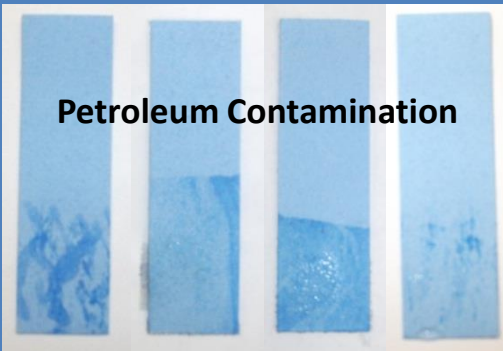

**Petroleum Contamination**

The test strips on the left are all examples where the strip has absorbed petroleum from a contaminated DEF sample. The higher the concentration of petroleum, the more that will be absorbed by the test strip. Shown in the example on the right, clean uncontaminated DEF will not absorb into the strip at all and no part of the test strip will change color.



**Clean DEF**

Refractometers like the ones on the right are available to test the DEF concentration. These testers **DO NOT** test for contamination and should only be used to determine the DEF concentration level.



**NOTE:** If petroleum is found in the DEF, the entire system will need to be replaced including the tank, pump, heater/sender, heated line and injector. Petroleum contamination is non-warrantable.

# DEF System Service Tips

## Reductant Tank Cleaning



Reductant tank cleaning procedures can be found in the WSM, Section 303-08 (Engine Emission Control) – Removal and Installation – Reductant Pump Assembly. The tank should be cleaned **BEFORE** the DEF pump is removed. **Dirt/debris that is not cleaned from ports will damage the DEF pump.**

**NOTICE:** Reductant tanks are typically dirty and should be cleaned prior to servicing the system. It is imperative that the top of the tank and heater/sender assembly are clean prior to removing the pump. Be sure to follow workshop manual (WSM) procedures when replacing any reductant system component.

Example of the pump removed without proper cleaning of the reductant tank

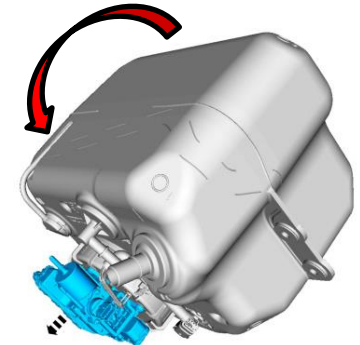

The small space between the pump and tank allow dirt to become trapped. Be sure to flush out the tank-to-pump mating surfaces with clean water prior to pump removal.



Residual dirt that may be present after the pump is removed can be flushed out using the priming syringe and clean DEF. When removing the pump, it is important to keep the tank at an angle to prevent dirt from falling into the pump ports.

**NOTE:** The reductant tank must be cleaned **BEFORE** the pump is removed to prevent repeat repairs.

# DEF System Service Tips

## Reductant Pump Replacement



**NOTICE:** Do Not use any grease, lube, oil, brake clean or other type of product that contains any type of petroleum to lubricate the O-rings or clean the DEF pump. Only use water to clean the tank/pump and only use water or clean DEF to lubricate reductant system components. Using lubricants on the O-rings will damage the pump.



When replacing the reductant pump assembly be sure to **discard the old O-rings** and **use the new O-rings provided in the assembly kit** that comes with the replacement pump. Also provided in the assembly kit is a syringe and instructions for priming the new pump with clean DEF. Steps for O-ring installation are included in the Reductant Pump Removal and Installation procedure located in the WSM, Section 303-08.

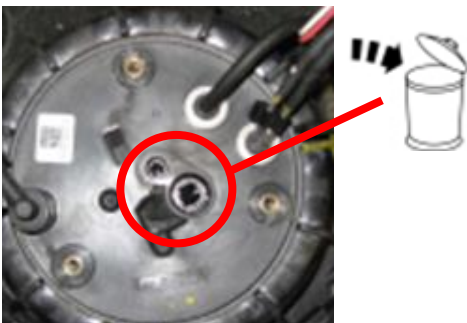

Diesel Exhaust Fluid (DEF) GSB  
Ver. 2.0

**DEF priming syringe and O-rings provided in kit**



Ford Motor Company



Reductant pump priming

# DEF System Service Tips

## DEF Crystal Formation

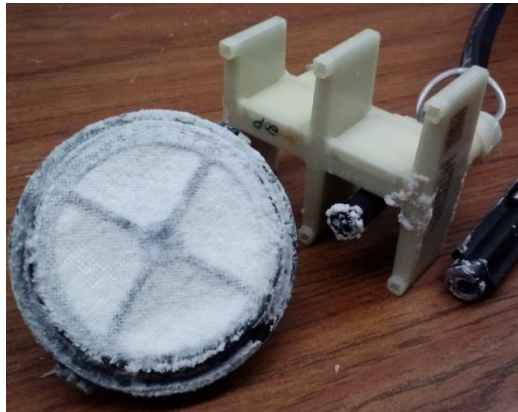

The photos to the left show components coated in clean liquid DEF and left to dry for 12 hours. The photos below are of the same components shortly after they were rinsed with clean warm water.

**NOTICE:** As DEF dries, crystals will form as the water evaporates. This is not contamination but is a normal characteristic of DEF. DEF crystals will dissolve in clean DEF or water. Warm water will dissolve the crystals more quickly than DEF. Even very large crystals will dissolve in water or clean DEF.





## DEF System Service Tips

### IDS Service Functions

Shown here are the SCR system function options located within the IDS. Detailed instructions on how to perform each test are displayed on the IDS when the test is selected.

- **[SCR System Emptying](#)** – Used for emptying the DEF tank in preparation for removal. It is not designed to empty the tank when contaminated with petroleum.
- **[SCR System Refill Activation](#)** – Used to reset the level indicator after replacing the heater/sender assembly or when the PCM does not recognize that the tank has been refilled.
- **[SCR Parameter Reset](#)** – Used to reset the DEF system parameters after component replacement.
- **[SCR Visual Leak Check](#)** – Pressurizes the DEF system so it can be visually inspected for leaks and verify the system is not bleeding off pressure.
- **[SCR Dosing Measurement Test](#)** – Designed to measure the performance of the reductant pump (supply module) to ensure it is capable of supplying enough DEF.

